

Brake Caliper DT 200 FEM ... NC

spring activated – electrohydraulically released
 Drum Brake according to DIN 15 435



Features	Code
Brake Caliper	D
Drum Brake	T
Frame size 200	200
Spring activated	F
Electrohydraulically released	E
Manual adjustment to accommodate friction block wear	M
Thrusters 451 or 452 are available	451 452
Material: cast	NC

Example for ordering

Brake Caliper DT 200 FEM, thruster 452, material: cast

DT 200 FEM - 452 - NC

Technical Data

	Brake Caliper DT 200 FEM ... NC	
	with thruster 451	with thruster 452
Brake drum diameter	Braking torque	Braking torque
mm	Nm	Nm
200	230	310
Clamping force	2875 N	3875 N
Braking torque adjustable (optional)	20 - 100%	20 - 100%
Nominal power	130 W	180 W
Oil volume	1,4 l	2,5 l
Voltage	230/400 V	230/400 V
Weight	26 kg	31 kg

The braking torques shown in the table are based on a theoretical friction coefficient of 0,4.

Brake Caliper DT 200 FEM ... NC

spring activated – electrohydraulically released
 Drum Brake according to DIN 15 435

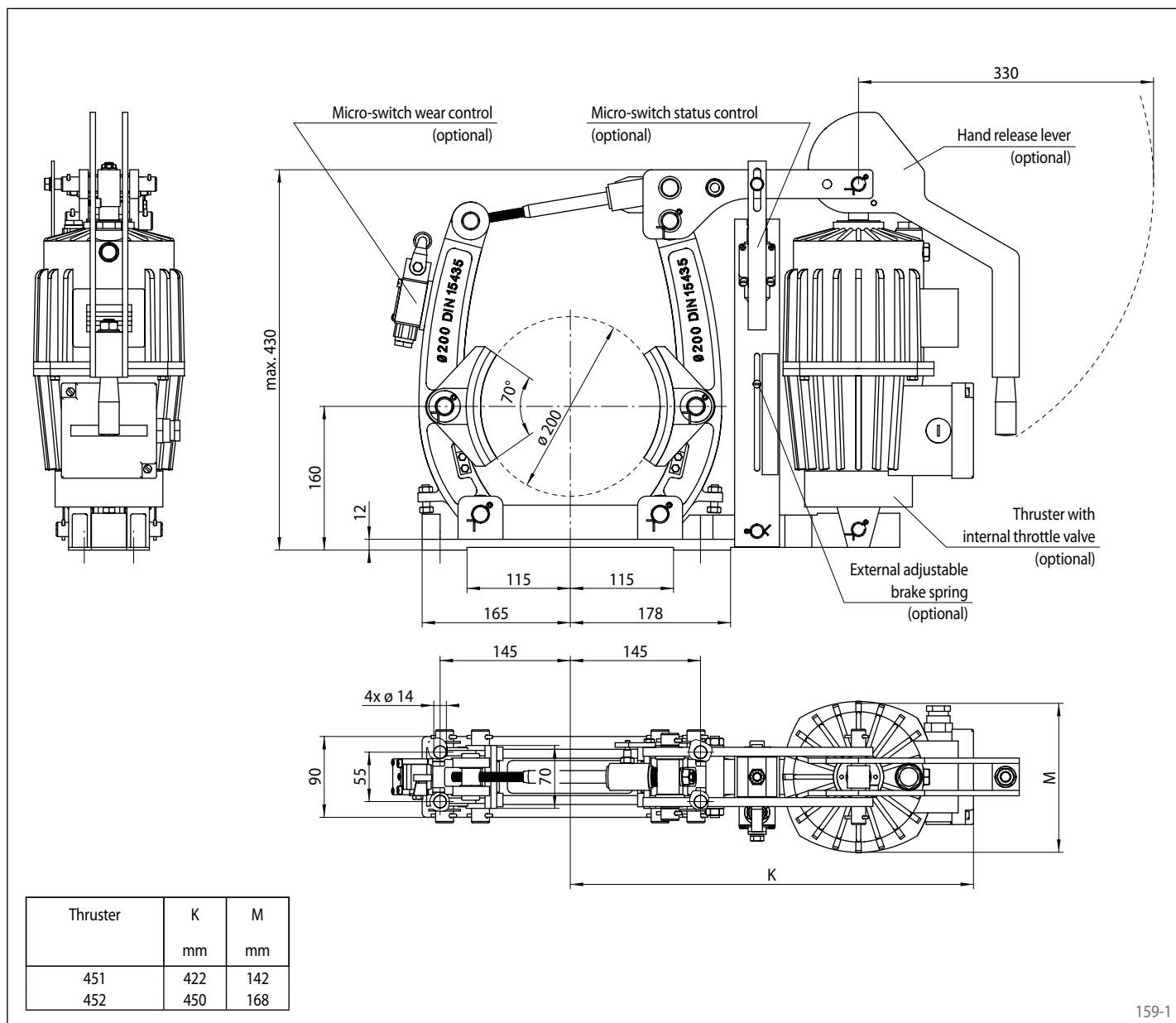

159-1

Options

- External adjustable brake spring
- Micro-switch wear control
- Micro-switch status control
- Hand release lever
- Thruster with internal throttle valve
- Thruster in heat resistant design
- Corrosion protected design
- Wider brake shoes and brake drums